

Design and Development of Real-Time Data Acquisition of Photovoltaic Panel Parameters via IoT

Kutaiba K. Khaleel^{1, a)}, Thamir H. Atyia^{1, b)}, Ahmed M. T. Ibraheem Al-Naib^{2, c)}
gutiaba.k.khaleel43870@st.tu.edu.iq, dr.thamir.atyia@tu.edu.iq, ahmed_alnaib2018@ntu.edu.iq

1. Electrical Engineering, Tikrit University, Iraq

2. Technical Engineering College/ Mosul, Northern Technical University, Iraq

Corresponding author: Kutaiba Khalaf. Khaleel, gutiaba.k.khaleel43870@st.tu.edu.iq

Co-authors: Thamir H. Atyia: dr.thamir.atyia@tu.edu.iq, Ahmed M. T. Ibraheem Al-Naib:

ahmed_alnaib2018@ntu.edu.iq

Received: 28-06-2022, **Accepted:** 12-07-2022, **Published online:** ***18-07-2022

Abstract. In recent years, there has been an urgent need in the world for electricity. It has been increasing constantly with the expansion of energy consumption via traditional energy sources which are depleting. The world has needed to turn to alternative energy, which is represented by renewable energy. The most important and most efficient of these is solar energy, and to get the maximum value of this energy with the highest efficiency, there should be direct monitoring of the performance of these solar panels. So, in this study, the Internet of Things (IoT) was used as a remote monitoring system to obtain the main factors like load current, terminal voltage, consumption power, temperature, humidity, and light intensity. The values were real and accurate, depending on the use of Arduino and sensors to measure the above-mentioned determinants and then using Wi-Fi technology to send the data that was processed in the circuit. Then the thing speak platform was used to display, analyze, and store the results in real-time.

Keywords: Solar system monitoring, Internet of things, On-Line monitoring, Arduino, Data sending.

Introduction

In recent years renewable energy sources such as wind and solar power have been receiving a lot of attention by many scholars and researchers. PV panels are employed in a variety of applications today, including battery charging, lighting, household power supply, satellite power systems, water pumping, and many more[1]. Now electricity is required for daily activities. Using photovoltaic (PV) electricity from the sun (renewable energy) is a wise choice[2]. Solar energy is a very large and unlimited source of energy. The energy that reaches Earth from the Sun is about 1.73×10^{17} Watts[3], which is several thousand times more than the current consumption rating of all energy sources used on Earth. The use of solar energy and its availability varies widely with time[4]. Solar electricity has significant advantages over other sustainable sources such as wind, waves, tides, geothermal energy, natural fossil fuels, and other commonly

used conventional sources[5]. The IoT plays increasingly an important role in human daily life as it enables him to communicate with industrial devices and projects directly through the Internet. The devices are linked with each other on the one hand and with people on the other hand, and give them the ability to control over them remotely. Hence, the exchange of data and information enable monitor devices and control their work, whether solar panels or other systems using an Internet connection. PV monitoring systems are designed to provide continuous, accurate information on a variety of characteristics, including fault detection, stored energy, extracted energy, and time analysis of the plant, in addition to everything that includes energy consumption. Furthermore, the observed data may be utilized for preventative maintenance, early warning detection, and examining whether fluctuations occur, among other things[6].

In the present, technology is closely linking people and things, and there is a significant increase in people's dependence on the internet.

Therefore, the IoT has taken on a major role in education and has had a significant impact on most human life activities[7].

In this experimental study, there is possibility to use three methods to view the results of the monitoring system. The first direct method is by connecting the Liquid Crystal Display LCD 4 × 20 with the I2C interface module. In the second method, the serial monitor of the computer was taken advantage of by connecting it via a USB cable to the Adriano board[8]. The last and most important method is the smart web monitoring on the Thing Speak platform, which uses a Wi-Fi module (ESP3266) on a smartphone or PC.

Literature Review

Fawzi Al-Naima and Abdullah Hamad in[9] suggested a low-cost PV panel monitoring system based on a cloud database that stores and displays huge amounts of data on the state of solar panels via a specialized GUI website built using PHP, HTML, and CSS computer languages. Krismadinata et al [10]. They have suggested that technology makes monitor PV panels discovering defects easily in real-time due to its simplicity. The study compares monitoring and measuring voltage values [11] . This paper assumes a real-time solar panel monitoring system via the Arduino UNO Board that connects sensors for current, voltage, and temperature. So, the researcher was able to monitor the values of the aforementioned sensors through a smartphone.

Recently, Jamil et al. [12] demonstrated a performance monitoring system for floating solar PV installations based on Arduino. The Arduino Nano was used as the main controller in this technique. Electrical characteristics which are voltage, current and power of solar PV panels with a power output of 10 W were also measured. Furthermore, the module's monitoring was carried out on both a floating and a land-based system. The floating system's power production and efficiency were found to be higher than the land systems. Because the proposed system is easier to implement, it may be built with high power monitoring abilities.

Proposed system design

In this study, a low-cost data acquisition system for monitoring electrical and environmental parameters in a solar station is built since data must be gathered, processed, stored, and evaluated in an IoT setup. The Arduino UNO R3 board, has been supported by the ESP8266 module, serves as the microcontroller in the

proposed monitoring system, acquiring and processing data from various sensors before transmitting the processed data to the Thing Speak cloud and servers through Wi-Fi. There are two stages to data communication: The first stage involves inter-integrated circuit protocol (I2C) connection between sensors and the controller, followed by Wi-Fi protocol communication between the controller and the cloud service application. The data acquired by the different sensors is either saved locally or in the cloud (webserver). Client and server requests form the basis of the interaction. The client sends an HTTP request, and the server responds. Communication between the various elements of the web is defined by this protocol. The block diagram of the suggested IoT system for monitoring solar plants is shown in Figure 1.

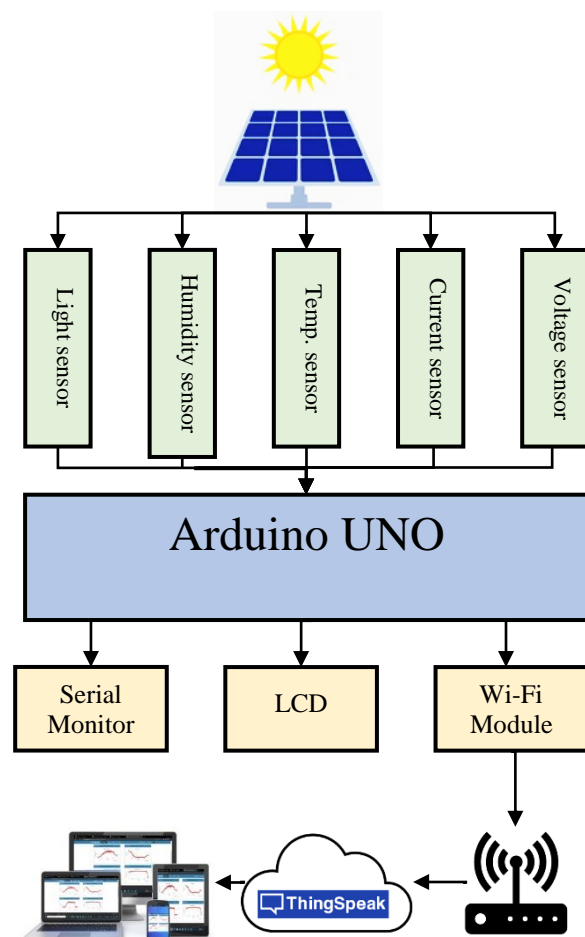

Figure 1. Block diagram of the proposed system

Methodology

To carry out the process of measuring and monitoring the solar panel system, it requires the availability of a solar cell system and several measurement devices and tools, in addition to the availability of some programs for programming the

processor used in the study, in addition to providing a platform for monitoring and analyzing the results obtained through smart measuring devices such as sensors. the proposed system is divided into two main parts:

Hardware

According to the practical connection of the proposed system, an experimental scheme can be drawn as shown in Figure 2, which includes all components of the system as well as the stage and mechanism running the proposed system, starting with the process of measuring the voltage and current values of the solar panels and the surrounding weather conditions through sensors, passing through the calibration and treatment process that takes place inside the microcontroller in the Arduino Uno, as well as the process of sending data by the sending unit and ending with the currency of receiving data and displaying it on a smartphone or computer through the ThingSpeak platform.

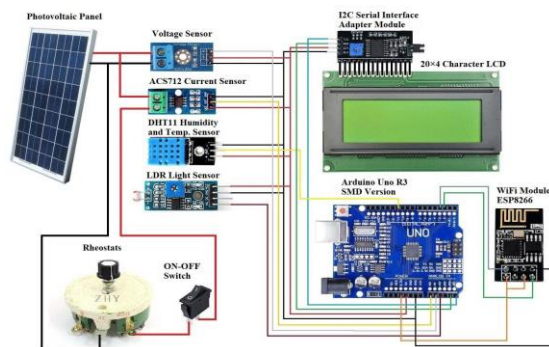

Figure 2. Experimental scheme of the proposed system

Solar panel

A solar cell, also known as a photovoltaic cell, is a device that uses solar radiation to generate electricity. The plates are made of many absorbent materials, and each one differs from the other due to the variable production and quality processes. Silicon is used in the bulk of panels of all kinds, whether they are monocrystalline, polycrystalline, or other types. Each solar panel has a distinct price and efficiency depending on its design[13]. A 30-watt polycrystalline solar panel was used to manage the proposed study and the panel specifications under Standard Test Conditions (STC): The air mass is AM 1.5, the irradiance is 1000W/m², and the cell temperature is 25°C. Peak power (P_{max}) is 30 watts, voltage (V_{mp}) is 17.8V, current (I_{mp}) is 1.69A, open-circuit voltage (V_{oc}) is 21.8V, and short circuit current is 1.85A.

Arduino UNO

The Arduino Uno is an open-source microcontroller board using an ATmega328 processor unit. The board contains 6 analog input pins, a USB cable port, 14 digital input or output pins, a 16MHz crystal oscillator, a reset button, a voltage regulator, LEDs, and other components. These parts act to enhance the microcontroller, powered by 9-12 DC volts, or just connected with a USB cable to the computer, which can be used to upload the source code software. It is running on a 5V DC source. The drive of the Arduino UNO combines high reliability with functionality and easiness. It connects solar panels to the Internet of Things[14].

Voltage Sensor

A voltage sensor is a simplified unit that works as a voltage divider and can be used with the Arduino or with other microcontrollers operating at a voltage of 5 volts. With the microcontroller, in this study, the sensor used has a (0–25) volt range. The voltage sensor (25V), which is used in our proposed research, contains a whole of five pins. Three male header pins are on the Arduino side, and two screw terminal female ports are on the Photovoltaic side. The external voltage source should be connected to the VCC and GND pins of the screw terminal, i.e., the voltage that has to be measured. The three male ports are called by the symbols +, –, and S. The S pin is the sense port, and it must be connected to the analog input of the Arduino board. While the GND port should be connected to the – port. The + port (which is denoted as an N/C port) is not connected to anything and can be linked to the 5 v of the Arduino port. A crucial aspect of the voltage sensor is its schematic. The Voltage Sensor is essentially a voltage divider made up of two resistors with resistances of 30K and 7.5K. Use equation (1) to determine the sensor output voltage.

$$V_{out} = V_{in} \times \frac{R_2}{R_1 + R_2} \quad (1)$$

Current Sensor

The current sensor, Acs712, is based on the hall effect. It is capable of measuring both direct and alternating currents. It is a sensor of the linear kind. Allegro created this highly well-known integrated circuit. It provides noise suppression and a very fast reaction time. The output error is approximately 1.5%. However, it may be reduced

with some clever programming and multiplying the observed value by the sensor's standard error. ACS712ELCTR-05B: Its output sensitivity is 185 mv/A, and it can measure current in the range of plus or minus 5 amps[15]. Every time an ampere is passed through the Hall effect sensor, there will be 185 millivolts at the output pin of the current sensor[16].

Humidity and Temperature Sensor (DHT11)

The DHT11 sensor is a low-cost temperature and humidity sensor that is used in a wide variety of control and monitoring projects. Within a specified range, the temperature does not exceed 50 and does not fall below 0 degrees Celsius, with an accuracy rate not exceeding two degrees. DHT11 features a high level of quality, a quick reaction time, and a high level of stability. It has a thermistor incorporated into it that measures temperature for temperature measurement. This sensor was also calibrated with a good thermometer to make sure the data was correct [17].

Light Sensor (LDR)

A high-quality LM393 voltage comparator is used in this LM393 Photosensitive Light-Dependent Control Sensor Module. The comparator output signal produces a clean and excellent waveform when employing the sensitive type of photosensitive resistance sensor. With a 15mA driving capability and an adjustable potentiometer, the brightness of the light detected can be adjusted. The working voltage ranges from 3.3-5 volts. Where output refers to the output of a digital switch. Because this module is highly sensitive, it is commonly used to measure ambient illumination and the intensity of the light. When DO output is at a high level with no light or when the light intensity does not reach the threshold, the D_o (Digital output) output of the module is at its lowest value[18].

ESP8266 (Wi-Fi Module)

This module is a self-contained system on a chip. It doesn't essentially require a microcontroller to operate inputs and outputs values as we do normally with an Arduino board, for instance, because of the ESP-01's performance as a computer. The ESP8266 might host an application or delegate all Wi-Fi networking functions to a separate application processor. The ESP8266 module comes pre-programmed with code, so all we have to do is plug it into the Arduino board and start sending and receiving data. It also has greater

Wi-Fi capabilities than a Wi-Fi Shield. In addition to its excellent efficiency, speed, and dependability, the ESP8266 module is inexpensive when compared to other modules [19].

LCD (Liquid Crystal Display)

An LCD module was used to be able to display all of the measurer parameters in real-time using the Arduino IDE's serial monitor as a user interface. Because it communicates with the Arduino board through the I2C bus, this shield only requires two digital pins to connect. Software may be used to control the lighting. The 4*20 LCD panel turns on with each iteration, displaying the data collected by the sensors[4].

Software

Arduino IDE software

The Arduino IDE (Integrated Development Environment) is based on the Processing and Writing programming languages and was designed by Arduino. The IDE comes with a text editor for writing code, a compiler, and a debugger for compiling and debugging. It supports the languages C and C++ by following particular code structure requirements[20][21]. The Arduino IDE includes a software library from the Wiring Project, which includes many common input and output processes. A program in this IDE only needs two basic functions: one to set up all modes and the other to set up various pins. A loop is another function that executes commands in a cyclic pattern. The Arduino IDE uses the avrdude software to convert executable code into a text file in hexadecimal format, which is subsequently loaded into the firmware of the microcontroller board by a loader program[22].

The flowchart shown in Figure 3 dedicated to the work of the algorithm of the program written using the Arduino IDE 1.8.19 begins with the process of defining the libraries of each device or module that is connected to the Arduino Uno board, such as sensors, display, and Wi-Fi transmitter unit, in addition to defining the values of the constants and variables used in the algorithm. Also, when determining the inputs and outputs of the Arduino UNO board pins and specifying their type, they can be analog or digital values, and during this stage, the initial values of the variables are determined. In the second stage, which is called the void setup, the platforms on which the results are displayed can be controlled and managed, such as the operation of the LCD with size (4 * 20) characters, which is connected with I2C as mentioned before, and the Arduino IDE

1.8.19 (serial monitor) 9600, in addition to the display of results and network status of the system on the serial monitor 115200. Arithmetic and logical commands can be written on the same stage. While in the third stage, which is the final stage in the algorithm, which is called the void loop, most of the arithmetic, mathematical, logical operations, processing, calibration, displaying results, sending data, timing, ending the program, etc.

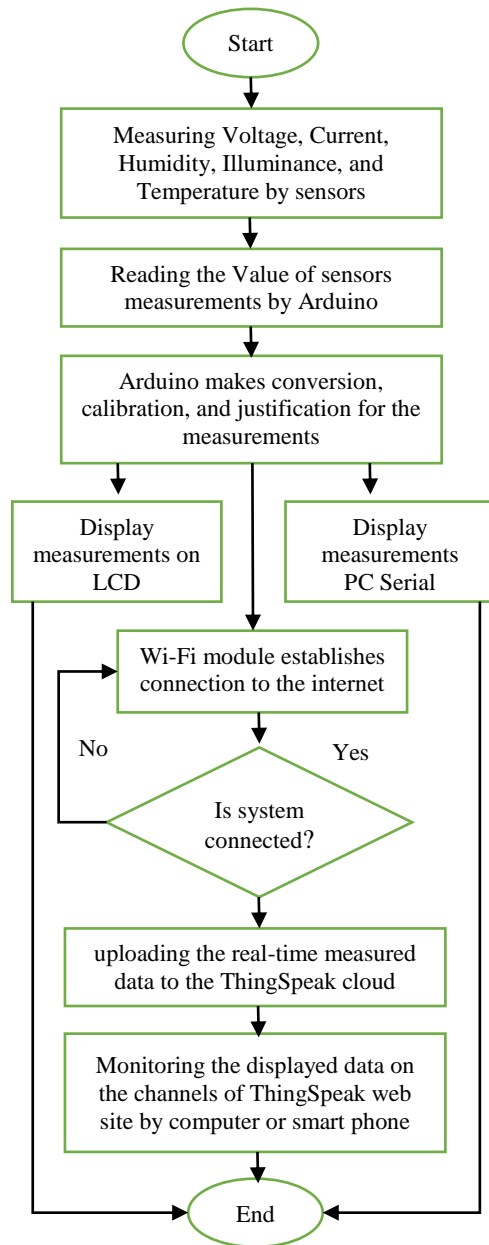

Figure 3. Flowchart of the proposed system

ThingSpeak Platform

ThingSpeak is a platform that provides several services geared towards the development of IoT applications. It can collect data from sensors in real-time, show it in charts, and build plugins and apps to integrate with web services, social networks, and other APIs. ThingSpeak, an open IoT data platform based on public cloud technology, was chosen for its wide range of third-party platforms, including Arduino and Twitter. The ThingSpeak platform uses HTTP to store and retrieve data from items over the internet. ThingSpeak allows you to use MATLAB to examine data without having to buy a MathWorks license. Data is sent to a specific channel by each monitoring system. These channels can be set up as either public or private (protected by a password). Furthermore, mobile applications enable smartphone monitoring of ThingSpeak channels. Users with a free account are restricted to ten million messages (3+ years at a minimum update period of 15 s) and eight fields per channel [23].

Results and Discussion

After connecting all the components of the electrical circuit shown in Figure 4, which represent the prototype and consists of the solar panel (30 watts) used in the experiment with sensors of voltage (Voltage divider), current (Acs712), light (LDR), temperature, and humidity (DHT11) with the Arduino board (Arduino UNO), which was enhanced with a Wi-Fi module (ESP8266 Wi-Fi Module) to send measurement data.



Figure 4. Prototype of the proposed system

After implementing the circuit linking, the source code has been written by a computer using Arduino IDE 1.8.19 software, which includes all commands, equations, arithmetic, calibration processing, the definition of the variables and constant characters, and commands for sending data, and then uploaded it to the microcontroller, which is responsible for reading all the values of sensors measurements connected to the Arduino board through input and output pins. At the same time, the sent data can be received through the

channel that was created on the ThingSpeak platform, which enables us to display all the received results in the form of curves, bars, gauges, etc. It is possible to analyze and visualize the results through the MATLAB link embedded in the ThingSpeak platform.

The results obtained from the monitoring system can be used to study the characteristics of photovoltaic cells, monitor the performance of the work of the solar cell system, and predict the occurrence of faults.

The load value which is used in the experiential work is 15 Ω. The results were completely identical to the practical results as shown in Figure 5 which displayed the six parameters temperature, humidity, illuminance, voltage, current, and power on a serial monitor, the same parameters

can be displayed on LCD as shown in Figure 6, while Figure 7 demonstrate the value of temperature, humidity, illuminance, voltage, current and power on ThingSpeak platform respectively. The results show the characteristic of the solar cell for a full day and the effect of the variation value of the six factors mentioned before, the obtained results demonstrated the accuracy, performance, and efficiency of the proposed monitoring system.

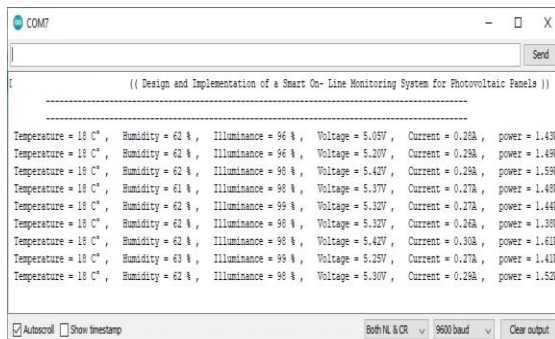

Figure 5. The displayed results on the Serial monitor



Figure 6. The displayed results on the LCD

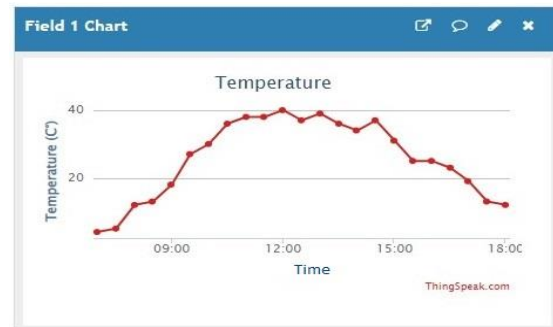

Figure 7. The displayed temperature on ThingSpeak

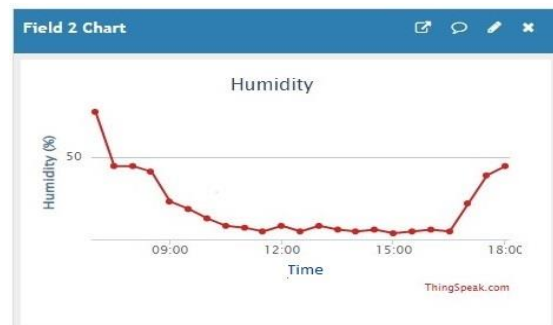

Figure 8. The displayed Humidity on ThingSpeak



Figure 9. The displayed Illuminance on ThingSpeak



Figure 10. The displayed load current on ThingSpeak



Figure 11. The displayed terminal voltage on ThingSpeak

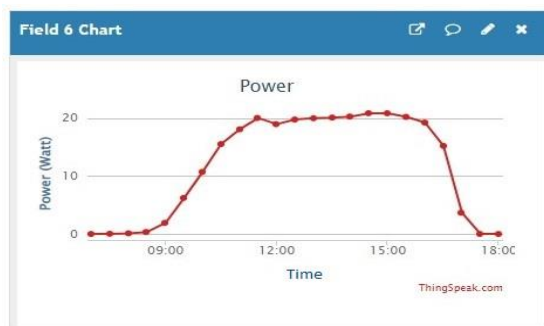

Figure 12. The displayed Power on ThingSpeak

Conclusion and future work

The design of real-time data acquisition of PV panel parameters via IoT was created and implemented to produce a low-cost, open-source PV monitoring system. First, it allows us to assess the performance of a PV system in real-time with precise findings. The monitoring system also provides a wealth of electrical and climatic data. This comparison verifies the electrical and meteorological data collected by several sensors, yielding errors of less than 1%. As a result, our suggested solution provides an advanced system for monitoring and dispatching electrical and meteorological data from distant PV power plants. This research will allow us to apply the proposed monitoring system to multiple practical applications, such as monitoring all types of electrical generating stations, as well as in other fields like agriculture and poultry to monitor the environmental condition and state of crops and animals, or in the health field to monitor the state of patients. This research also gives us the ability to use remote control units, like ones that can control temperature and humidity, ventilation, and turn on and off devices.

References

- [1]. AbduAllah, Z. M., Mahmood, O. T., & AL-Naib, A. M. I. (2014). Photovoltaic battery charging system based on PIC16F877A microcontroller. *International Journal of Engineering and Advanced Technology (IJEAT)*, 3(4), 27-31.
- [2]. Ahmed M. T. Ibraheem AL-Naib, "Modeling and Simulation of Solar Photovoltaic Array using MATLAB/Simulink", *AL-Taqani Journal*, Vol. 29, No. 1, 2016, PP. 55-65.
- [3]. Kalair, A., Abas, N., Saleem, M. S., Kalair, A. R., & Khan, N. (2021). Role of energy storage systems in energy transition from fossil fuels to renewables. *Energy Storage*, 3(1), e135.
- [4]. Bashar A. Hamad, Ahmed M. T. Ibraheem, "Design and Implementation of a Dual-Axis Solar Tracking System STS", *Northern Technical University Journal of Engineering and Technology*, Vol. 1, No.1, 2021, PP. 35-43.
- [5]. Adhya S, Saha D, Das A, Jana J, Saha H (2016) An IoT-based smart solar photovoltaic remote monitoring and control unit. In: 2016 2nd International Conference on Control, Instrumentation, Energy Communication, PP.32 -436.
- [6]. Al-Fuqaha A, Guizani M, Mohammadi M, Aledhari M, Ayyash M (2015) "Internet of Things: A Survey on Enabling Technologies", Protocols, and Applications *IEEE Commun Surv Tutor*, Vol. 17, No.4, PP. 2347-2376.
- [7]. Ali, M., Nazim, Z., Haroon, P. M., Azeem, P. W., Javed, K., Tariq, M., & Hussain, P. A. (2020). "An IoT-based approach for efficient home automation with Thing Speak", *International Journal of Advanced Computer Science and Applications*, 11(6).
- [8]. Ali, A. J., Ahmed M. T. Ibraheem, & Mahmood, O. T. (2020, February). "Design of A Smart Control and Protection System For A Three-Phase Generator Using Arduino", *IOP Conference Series: Materials Science and Engineering*, Vol. 745, No. 1.
- [9]. Al-Naima, F., & Hamad, A. (Nov. 2018,), "A Low-cost Solar Farm Monitoring System Based on Cloud Database", *IEEE International Conference on Innovation and Intelligence for Informatics, Computing, and Technologies*, PP. 1-5.
- [10]. Krismadinata, K., Kusuma, P., & Yahfizham, Y., "Design and Manufacture of Wireless Monitoring system of Photovoltaic Generation Employing Raspberry Pi", *ELKHA*, Vol.13, No. 1, PP. 19-24.

- [11]. Gusa, R. F., Sunanda, W., Dinata, I., & Handayani, T. P., "Monitoring system for the solar panel using smartphone-based microcontroller", *2018 2nd IEEE international conference on green energy and applications*, PP. 79-82.
- [12]. Jamil, N. A. A., Jumaat, S. A., Salimin, S., Abdullah, M. N., & Nor, A. F. M. (2020). Performance enhancement of solar powered floating photovoltaic system using arduino approach. *International Journal of Power Electronics and Drive Systems*, 11(2), 651.
- [13]. Ramu, S. K., Irudayaraj, G. C. R., & Elango, R. (2021), "An IoT-based Smart Monitoring Scheme for Solar PV Applications", *Electrical and Electronic Devices, Circuits, and Materials: Technological Challenges and Solutions*, PP. 211-233.
- [14]. Madadi, S., "A Study of Solar Power Monitoring System Using Internet of Things (IoT)", Vol. 6, Issue 5, May – 2021 *International Journal of Innovative Science and Research Technology*.
- [15]. Khair, U., Lubis, A. J., Agustha, I., & Zulfin, M. (2017, December). "Modeling and Simulation of Electrical Prevention System using Arduino Uno, GSM Modem, and ACS712 Current Sensor", *Journal of Physics: Conference Series*, Vol. 930, No. 1
- [16]. Micro Systems, A. ACS712–Datasheet. Available online: [HTTPS:// datasheet-pdf/view/168326/ALLEGRO/ACS712.html](https://datasheet-pdf/view/168326/ALLEGRO/ACS712.html)
- [17]. Cheddadi, Y., Cheddadi, H., Cheddadi, F., Errahimi, F., & Es-sbai, N. (2020), "Design and Implementation of an Intelligent Low-cost IoT Solution for Energy Monitoring of Photovoltaic Stations", *SN Applied Sciences*, 2, 1-11.
- [18]. Bashar A. Hamad, Ahmed M. T. Ibraheem, Ahmed G. Abdullah, "Design and Practical Implementation of Dual-Axis Solar Tracking System with Smart Monitoring System", *PRZEGLĄD ELEKTROTECHNICZNY JOURNAL*, Issue 10, 2020, PP. 151-155.
- [19]. <https://www.sparkfun.com/products/17146>
- [20]. Shaukhi, A. S. A., & Bakar, M. I. A. (2021), "Development of Wireless Photovoltaic (PV) Monitoring System", *Journal of Engineering Technology*, 9(1), PP. 29-35.
- [21]. Tellawar, M. P., & Chamat, N. (2019). "An IoT-based smart solar photovoltaic remote monitoring system", *International Journal of Engineering Research & Technology*, Vol. 8, No. 09, PP. 235-240.
- [22]. <https://www.arduino.cc/en/software>.
- [23]. López-Vargas, A., Fuentes, M., & Vivar, M. (2018), "IoT Application for Real-Time Monitoring of Solar Home Systems based on Arduino™ with 3G Connectivity", *IEEE Sensors Journal*, Vol. 19, No. 2, PP. 679-691.